

CZECH SILICAT FLOW CHART

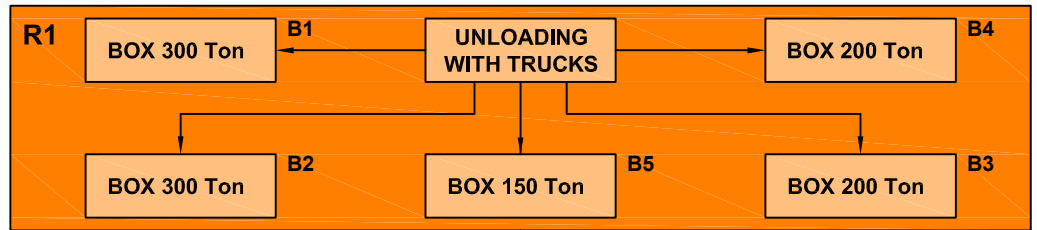

CRAIN LOAD SYSTEM

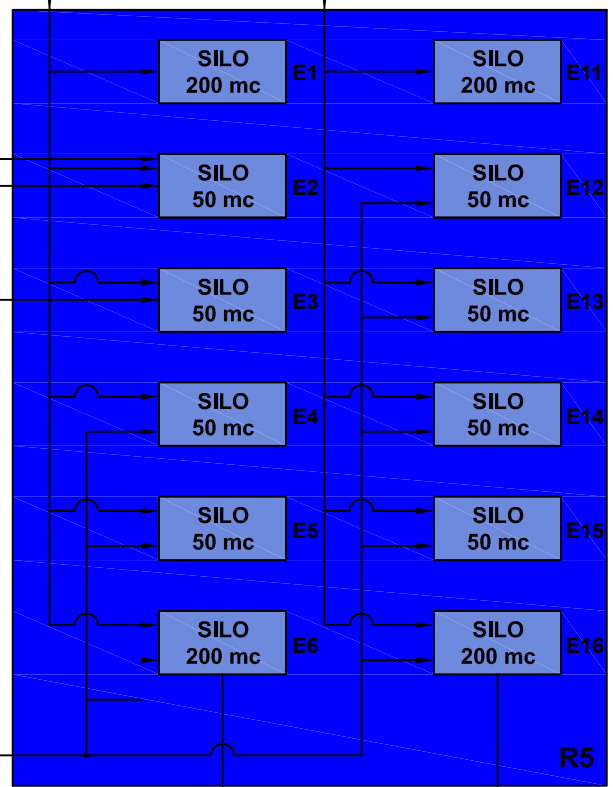
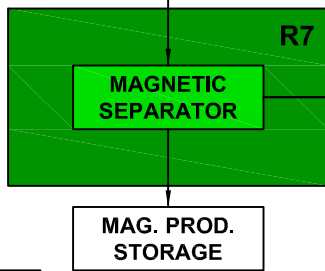
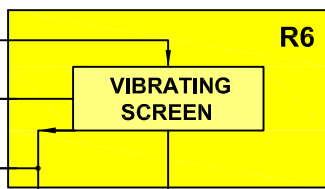
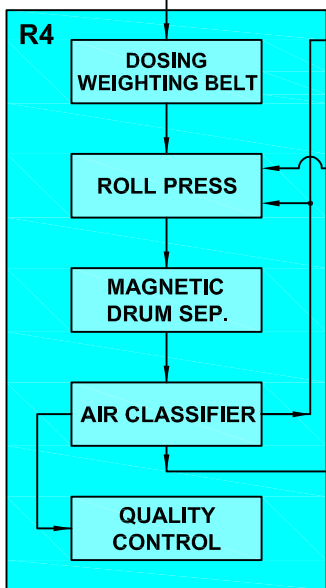
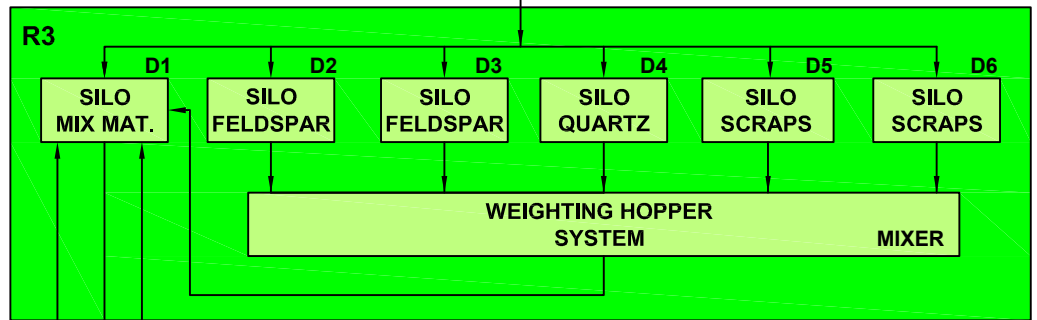
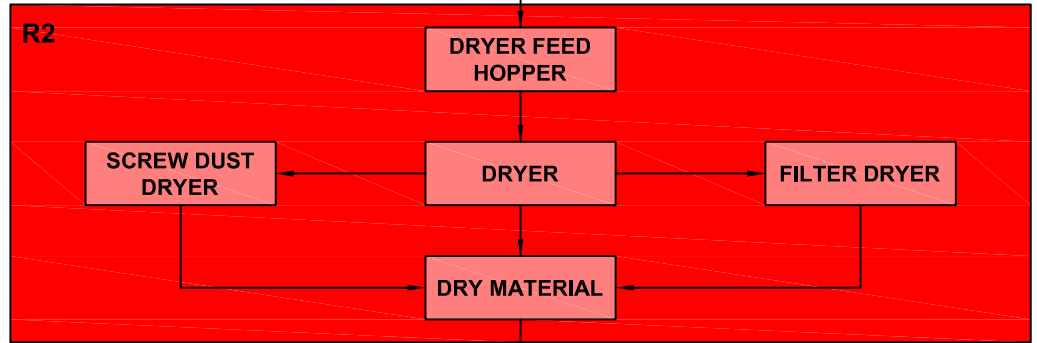

TANKS LOADING

TANKS LOADING

■ R1 Box storage raw material

■ R2 Drying plant

■ R3 Mixing plant

■ R4 Ventilation plant

■ R5 Silos storage finish product

■ R6 Screening plant

■ R7 Magnetic separation plant